

## 5.6 Bolts and floor sockets

### Care and Maintenance

Care and maintenance are important factors in ensuring that Allgood Hardware maintains the high quality finish for many years to come, and that working components give trouble-free operation. The frequency of maintenance will depend on the amount of use.

### Fixings

All Allgood Hardware items are fixed using Pozidriv/Supadriv screws and the correct screwdrivers must be used. Ask for Allgood Hardware XX5321/2/3 drivers. Do not use Phillips drivers as they are not compatible.

### Contents

- Care and maintenance
- Introduction
- Flush bolts
- Floor sockets
- Barrel bolts
  - Straight
  - Necked
- Heavy duty bolt
- Mortice bolt with knob turn
- Door chain

A bolt is defined simply as any locking device that is not operated by a key.

Allgood Hardware includes an extensive range of flush bolts and surface mounted barrel bolts, all of which are covered by the Allgood 10 year guarantee.

Many are available in the full range of metallic and Spectra colour coated finishes – 90 colours are available as standard – to complement the aesthetics of any interior.

This section also provides details of easy clean and dirt excluding floor sockets to suit the Allgood Hardware range of bolts, and the classic leather covered door chain.



### 7010

150 x 25mm lever action flush bolt with 'dovetail' shaped return, and flange to conceal mortice.

Finishes: SC • PC • MA • TA • PB • PZ

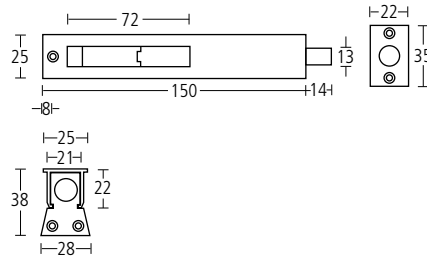
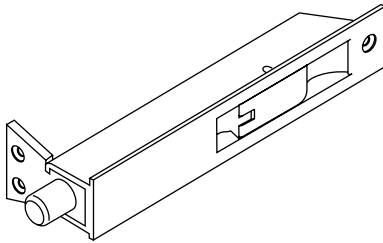

### 7010/0Q

Complete bolt set, comprising 2x7010 bolts, 7051 easy clean floor socket and intumescent pack for FD30 and FD60 fire doors.

Finishes: SC • MA • PC • PZ

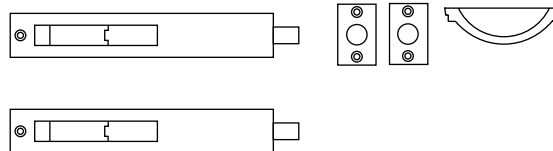

### 7010/2Q

Complete bolt set, comprising 1x7010 and 1x7012 bolts, 7051 easy clean floor socket and intumescent pack for FD30 and FD 60 fire doors.

Finishes: SC • MA • PC • PZ

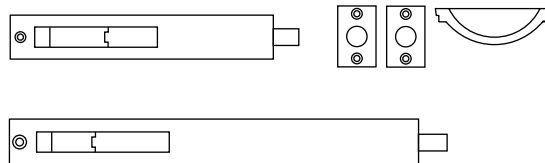

### 7010/3Q

Complete bolt set, comprising 1x7010 and 1x7013 bolts, 7051 easy clean floor socket and intumescent pack for FD30 and FD 60 fire doors.

Finishes: SC • MA • PC • PZ

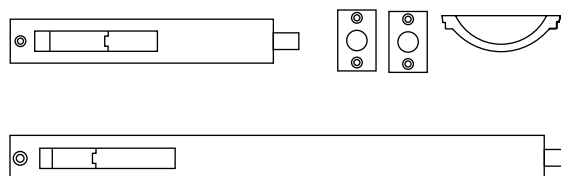

## 7012

225 x 25mm lever action flush bolt with 'dovetail' shaped return, and flange to conceal mortice.

Finishes: SC • PC • MA • TA • PB • PZ

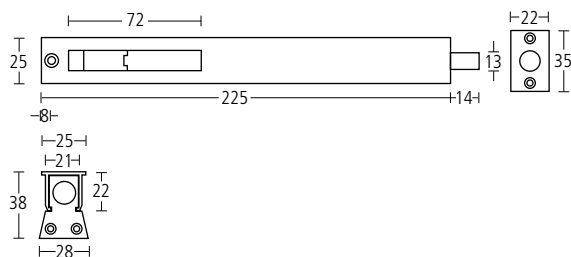
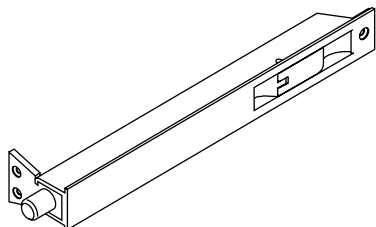

## 7012/2Q

Complete bolt set, comprising 2x7012 bolts, 7051 easy clean floor socket and intumescent pack for FD30 and FD 60 fire doors.

Finishes: SC • MA • PC • PZ

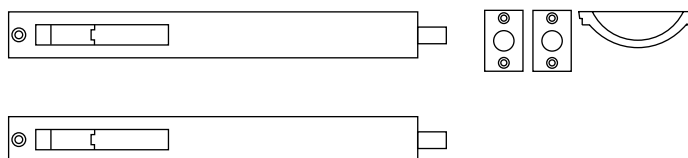

## 7012/3Q

Complete bolt set, comprising 1x7012 and 1x7013 bolts, 7051 easy clean floor socket and intumescent pack for FD30 and FD60 fire doors.

Finishes: SC • MA • PC • PZ

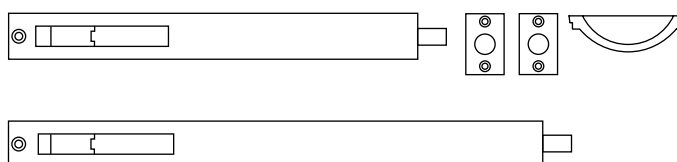

### 7013

300 x 25mm lever action flush bolt with 'dovetail' shaped return, and flange to conceal mortice.

Finishes: SC • PC • MA • TA • PB • PZ

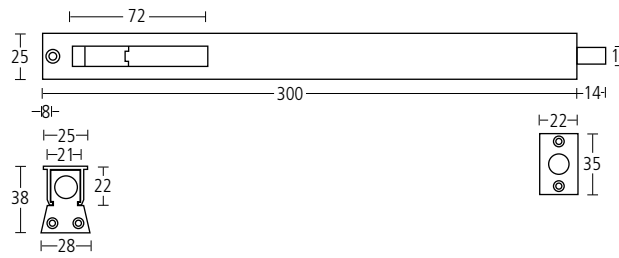
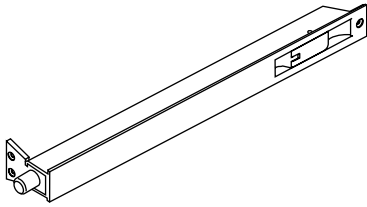

### 7013/3Q

Complete bolt set, comprising 2x7013 bolts, 7051 easy clean floor socket and intumescent pack for FD30 and FD60 fire doors.

Finishes: SC • MA • PC • PZ

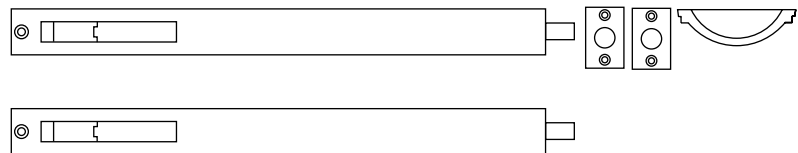

## 48800

Single 203 x 19mm lever action flush bolt.  
Supplied with flat strike plate.

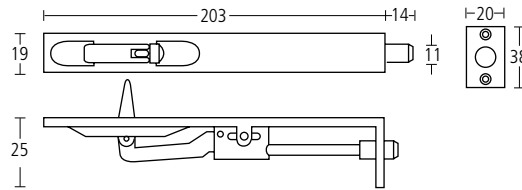
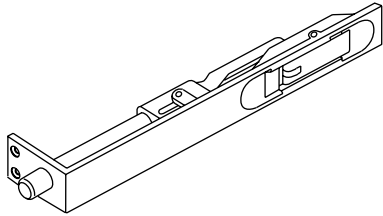

Finishes: AS • PB

Satin nickel plated – XX48800.4 (full ref.)

Polished chrome – XX48800.5 (full ref.)

Colour coated aluminium –  
XX48800C (full ref.)

## 48800/Q

Complete bolt set, comprising 2x48800 bolts, 7051 easy clean floor socket and intumescent pack for FD30 and FD60 fire doors.

Finishes: MA • PC

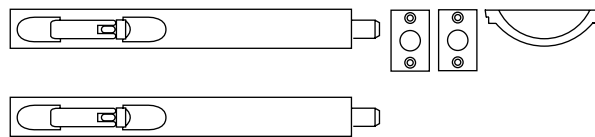

## XX48800/0Q

As above, with satin nickel plated finish.

## XX48800/1Q

Complete bolt set, comprising 1xXX48800 and 1xXX48801.4 bolts, 7051 easy clean floor socket and intumescent pack for FD30 and FD60 fire doors.

Satin nickel plated.

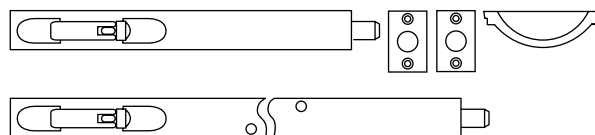

## XX48800/2Q

Complete bolt set, comprising 1x48800 and 1xXX48802.4 bolts, 7051 easy clean floor socket and intumescent pack for FD30 and FD60 fire doors.

Satin nickel plated.

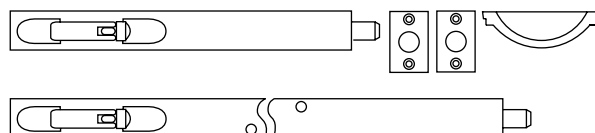

XX48801.4

457 x 19mm lever action flush bolt.  
Supplied with flat strike plate.  
Satin nickel plated finish.

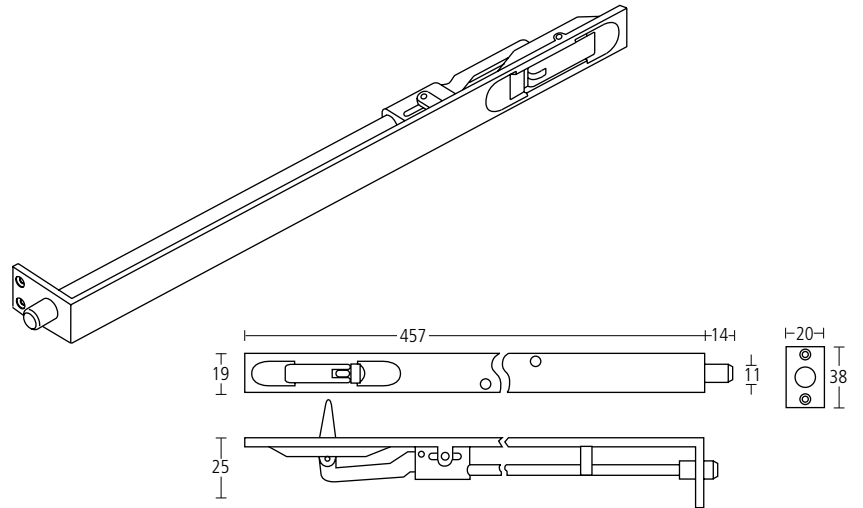

XX48802.4

609 x 19mm lever action flush bolt.  
Supplied with flat strike plate.  
Satin nickel plated finish

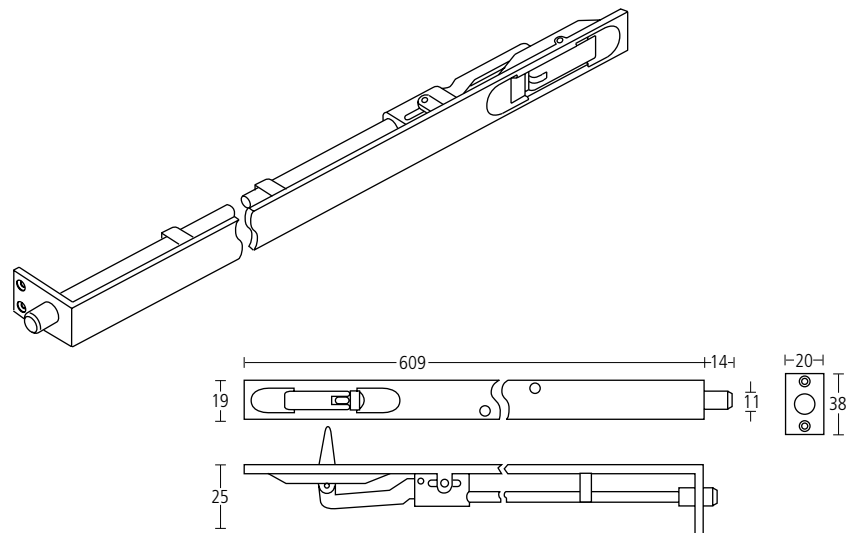

XX48803.4

914 x 19mm lever action flush bolt.  
Supplied with flat strike plate.  
Satin nickel plated finish

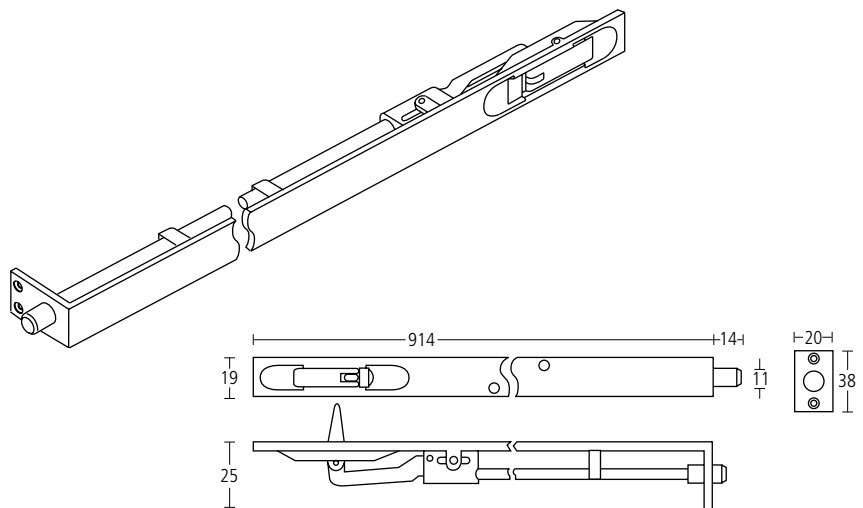

7014

300 x 25 x 22mm projecting knob slide flush mounted bolt, with 'dovetail' shaped return, and flange to conceal mortice.

Finishes: SC • PC • MA • TA • PB • PZ

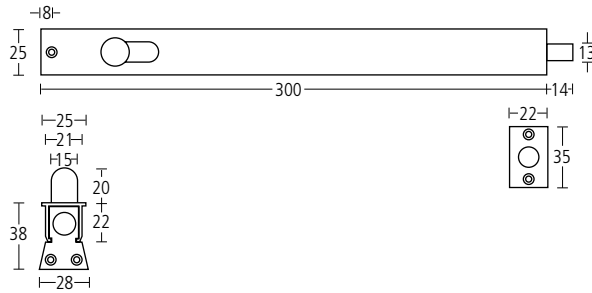
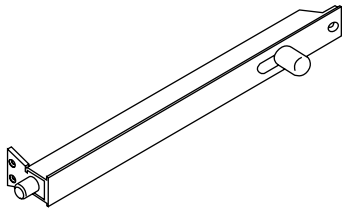

7018

150 x 25 x 22mm projecting knob slide flush mounted bolt, with 'dovetail' shaped return, and flange to conceal mortice.

Finishes: SC • PC • MA • TA • PB • PZ

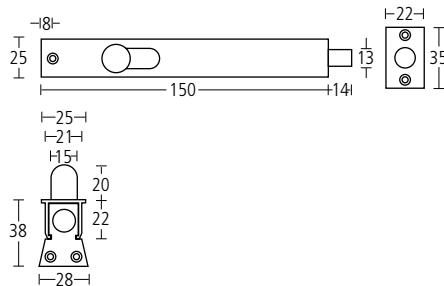
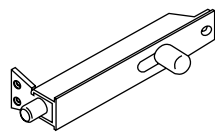

7051

Easy clean floor socket suitable for wood and stone.  
For use with flush bolts.

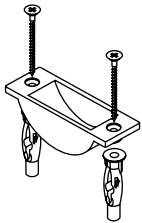

- Complete with rawplugs
- Automatically supplied with flush bolt kits

Finishes: SC • PC • MA • TA • PB • PZ

7053

Dirt excluding floor socket suitable for wood and stone.  
For use with 13mmø flush bolts.

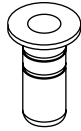

Finishes: SC • PC • MA • TA • PB • PZ



48812

Dirt excluding floor socket for wood and stone.  
For use with 11mmø flush bolts.



Finishes: PB

- Satin nickel plated – XX48812.4 (full ref.)
- Polished chrome – XX48812.5 (full ref.)

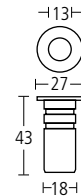

## 6953

75 x 35mm Dom straight surface bolt.

Finishes: MA • TA • PB • PC • PZ

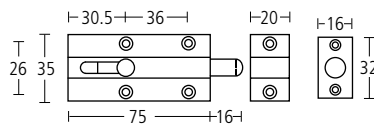
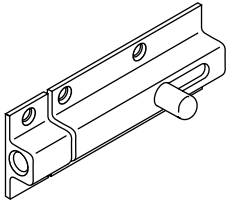

## 6954

150 x 35mm Dom straight surface bolt.

Finishes: MA • TA • PB • PC • PZ

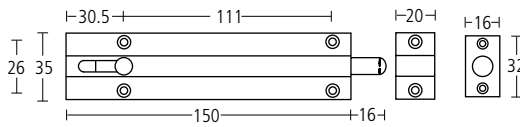
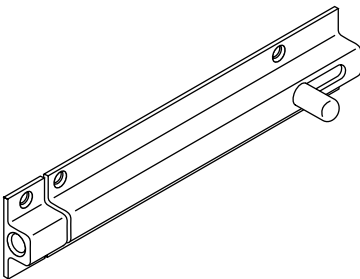

## 6955

300 x 35mm Dom straight surface bolt.

Finishes: MA • TA • PB • PC • PZ

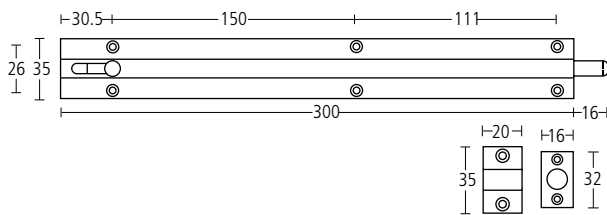
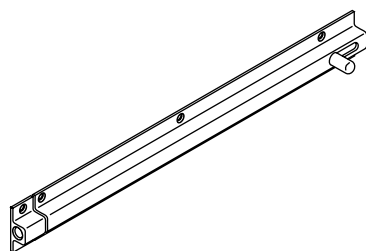

6963

75 x 35mm Dom necked surface bolt.

Finishes: MA • TA • PB • PC • PZ

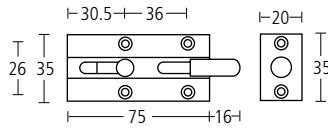
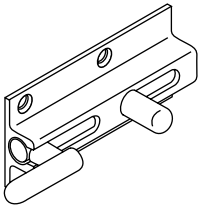

6964

150 x 35mm Dom necked surface bolt.

Finishes: MA • TA • PB • PC • PZ

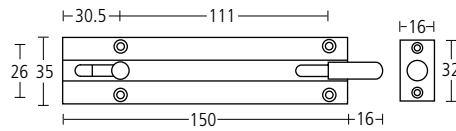
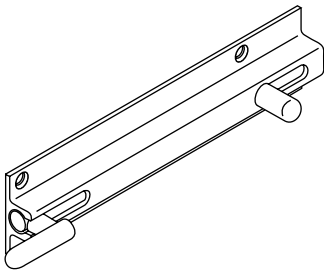

6965

300 x 35mm Dom necked surface bolt.

Finishes: MA • TA • PB • PC • PZ

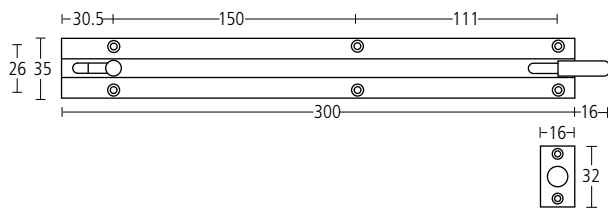
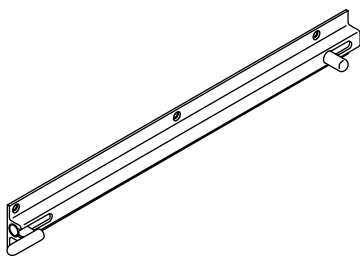

## 6970

152 x 38.5 x 40mm heavy duty surface bolt.

Finishes: MA • TA • PB • PC • PZ

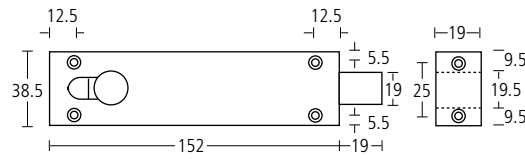
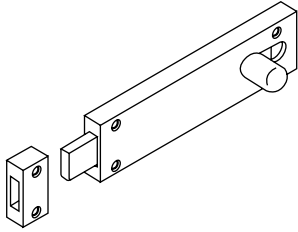

## 6971

Mortise bolt with knob turn.

Finishes: MA • TA • PB • PC • PZ

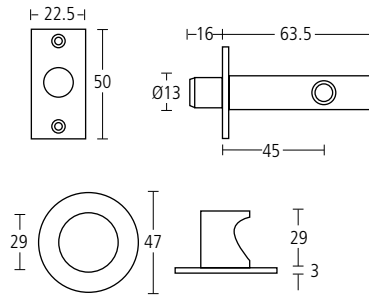
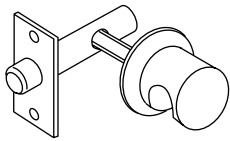

## 6972

152 x 38 x 13mm door chain, with black leather covered chain.

Finishes: MA • TA

